

LTR26 Series 315MHz/915MHz MP(+20dBm) RF LoRa Transceiver Modules

Features - Radio

- 315MHz/915MHz ISM Frequency Band, LoRa and (G)FSK modem, LLCC68 IC
- Data rate – Up to 300kbps for (G)FSK, Up to 62.5kbps for LoRa
- -126dBm Receiver Sensitivity (LoRa, SF-10, BW-250kHz)
- +20dBm RF Output Power (adjustable with 1dB step size)
- Buffer packet data, spectrum shaping, FEC-Forward Error Correction
- Low current consumption, 4.9mA in receive mode, 600nA in sleep mode
- Full radio configuration/control and modem/data parameters

Other

- Power Supply : 1.8V~3.6V
- Operating Temperature : -40°C~+85°C
- Small profile : 32.49mmx23.64mm (LTR26RSH9/LTR26RSH3)

27.73mmx23.64mm (LTR26CSH9/LTR26CSH3)

23.41mmx19.58mm (LTR26-S9/LTR26-S3)

27.73mmx19.58mm (LTR26-SC9/LTR26-SC3)

MPN	Frequency	Connector	RF Shield
LTR26RSH9	915MHz	SMA RF Connector	Yes
LTR26RSH3	315MHz	SMA RF Connector	Yes
LTR26CSH9	915MHz	U.FL RF Connector	Yes
LTR26CSH3	315MHz	U.FL RF Connector	Yes
LTR26-S9	915MHz	SMD/RF Pin	Yes
LTR26-S3	315MHz	SMD/RF Pin	Yes
LTR26-SC9	915MHz	SMD/U.FL RF Connector	Yes
LTR26-SC3	315MHz	SMD/U.FL RF Connector	Yes

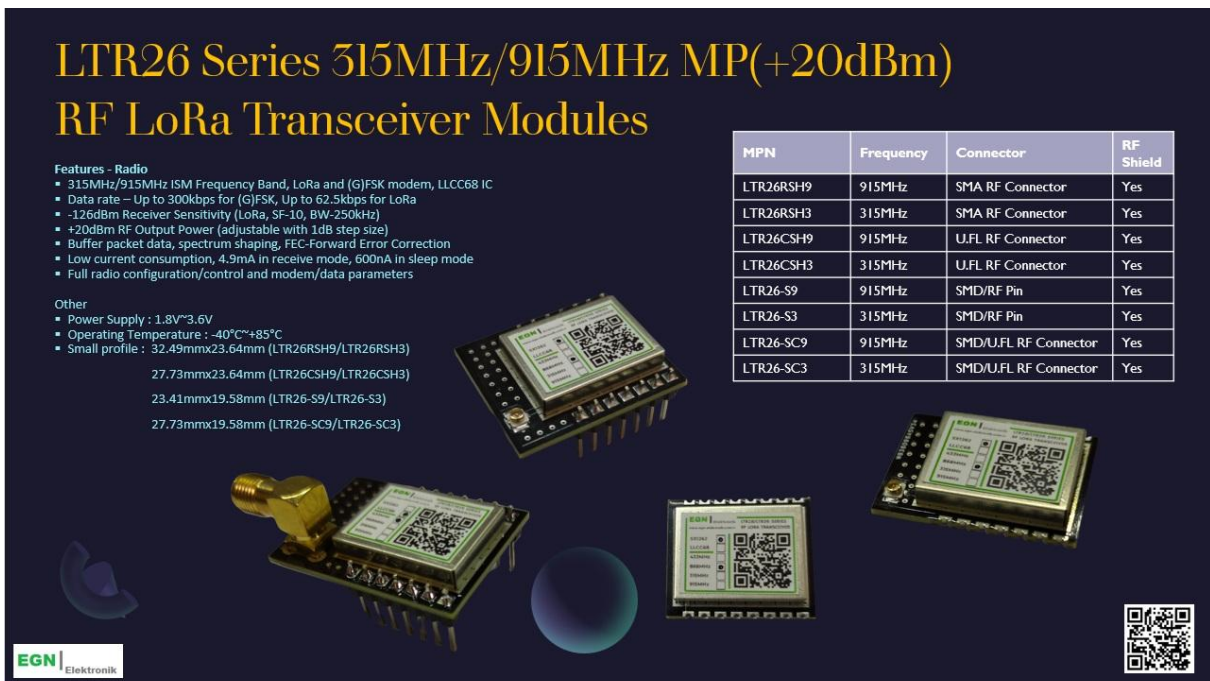

LTR26RSH3

315MHz/+20dBm LoRa RF Transceiver Module

Datasheet

TABLE OF CONTENTS

1.	LTR26RSH3 315MHz/+20dBm LoRa RF Transceiver Module in Brief	3
2.	LTR26RSH3 Technical Data	7
3.	Interfacing LTR26RSH3 to Host Controller	8
4.	Operational Modes	10
5.	Setting Modem, Transmitter & Receiver Parameters	11
6.	Module Aspects to Consider for User Application	14
7.	Drawings	19
8.	Ordering Information	20

Revision History

References

1. LTR26RSH3 315MHz/+20dBm LoRa RF Transceiver Module in Brief

LTR26RSH3 is a small size, compact, low power and easy to use 315MHz LoRa RF Transceiver module based on Semtech SX1262 Sub-GHz RF Transceiver IC. It supports both LoRa and G(FSK) modulations, provides radio configuration and control via the SPI interface and has up to -126dBm RF receiver sensitivity and up to +20dBm RF output power.

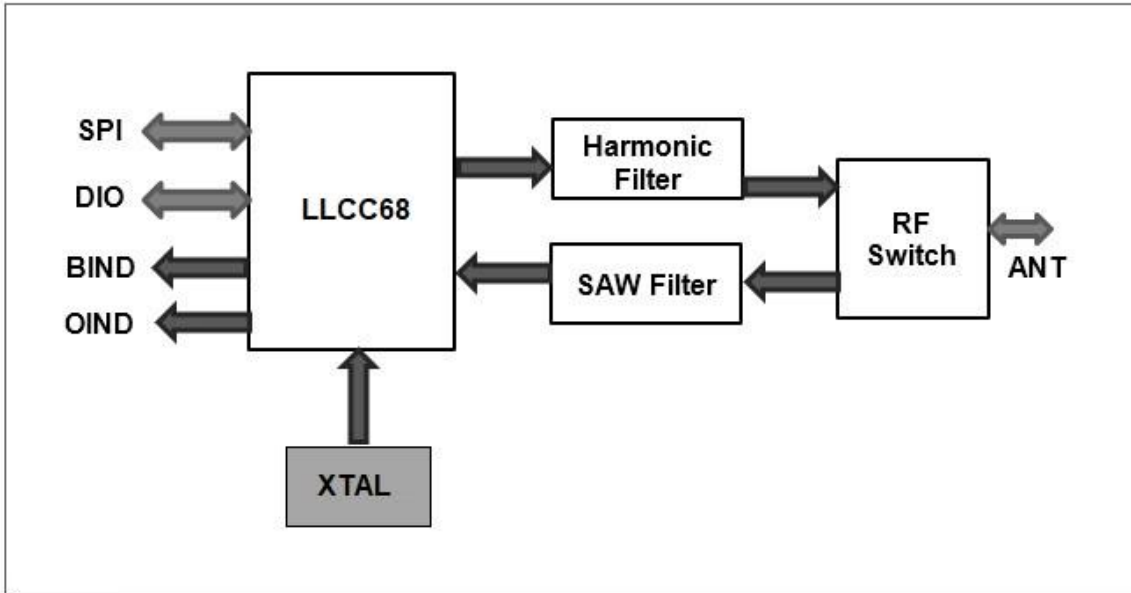

Fig.1 LTR26RSH3 functional blocks and interconnections

Features

- Wide supply voltage range, 1.8V~3.6V
- Operating frequency 315MHz with LoRa and (G)FSK modems
- Up to 62.5kbps bit rate for LoRa and up to 300kps bit rate for (G)FSK
- Packet mode with data buffer, data whitening codec, FEC-Forward Error Correction
- -126dBm Receiver sensitivity, (@SF10 and LoRa BW-125kHz)
- +20dBm RF output power (programmable with 1dB steps)
- High frequency stability, long range and high performance
- Low power consumption,
 - 4.6mA, sleep mode <600nA (in receive mode)
 - 90mA (in transmit mode,@20dBm)
- Radio configuration and control via SPI interface
- Fully programmable frequency, modem, packet parameters and radio operational modes
- Small Size - 32.49mmx23.64mm

Application Areas

- Low-cost consumer electronics applications, ISM band data communication
- Smart Building Automation
- Industrial Monitoring and Control
- Remote Control, Remote Keyless Entry, Remote AMR, Tag Reader
- Wireless Alarm and Security, Wireless Sensor Node



Fig.3 LTR26RSH3

LoRa Modulation Technique

The LTR26RSH3 uses Semtech’s patented LoRa modulation technique which combines spread spectrum modulation and forward error correction techniques to increase the range and robustness of radio communication links compared with traditional FSK or OOK based modulation. This high sensitivity, in contrast to conventional modulation techniques, permits an increase in link budget and increased immunity to in-band interference, combined with +20dBm RF power output yields industry leading link budget.

LoRa also provides significant advantages in both blocking and selectivity, solving the traditional design compromise between range, interference immunity and energy consumption. In LoRa mode the LTR26RSH3 offers ten bandwidth options as in table below.

Signal Bandwidth	0	1	2	3	4	5	6	7	8	9
BW_L (kHz)	7.81	10.42	15.63	20.83	31.25	41.67	62.5	125	250	500

Table 1. LTR26RSH3 LoRa Mode BW Options

The spread spectrum LoRa modulation is performed by representing each bit of payload information by multiple chips of information. The rate at which the spread information is sent is referred to as the symbol rate (Rs), the ratio between the nominal symbol rate and chip rate is the spreading factor and represents the number of symbols sent per bit of information. The range of parameters which can be configured are given in the following tables.

Spreading Factor (SF)	5	6	7	8	9	10	11	12
Chips/Symbol	32	64	128	256	512	1024	2048	4096
SNR (dB)	-2.5	-5.0	-7.5	-10.0	-12.5	-15.0	-17.5	-20.0

Table 2. LTR26RSH3 LoRa Mode Spreading Factors

Note that the spreading factor must be known in advance on both transmit and receive sides of the radio link as different spreading factors are orthogonal to each other. Note also the resulting signal to noise ratio (SNR) required at the receiver input. It is the capability to receive signals with negative SNR that increases the sensitivity, so link budget and range, of the LoRa receiver.

To further improve the robustness of the radio link LTR26RSH3 provides cyclic error coding with different coding rates. By using this coding scheme forward error detection and correction can be applied.

Differentiating Aspects of The LTR26RSH3 315MHz LoRa RF Transceiver Module

One performance contributor of LTR26RSH3 is use of 315MHz SAW filter in RX path providing high selectivity which consequently providing high interference immunity and high sensitivity resulting in long range and exceptional bit error rate performance even in highly interfering environments with low SNR/SINR values, SAW filter characteristics are given below.

LTR26RSH3 is optimized for +20dBm RF power output, PA settings should be arranged according to Section 5. Setting Modem, Transmitter & Receiver Parameters as in Table12B, for other PA configuration settings matching is not optimum and the RF power output may be different from intended usually at a higher current consumption.

315MHz SAW Filter for High Selectivity and Interference Immunity

LTR26RSH3 includes a highly selective 315MHz SAW filter in RF frontend in RX path for additional interference suppression. The characteristics of the SAW filter are given in Table 3 and Fig 4 below.

Parameter	Test Conditions	Min	Typical	Max	Unit
Center Frequency		-	315	-	MHz
3-dB Bandwidth		-	4	-	MHz
Attenuation	293 to 293.9MHz	53	58		dB
	304 to 304.6MHz	48	53		
	325.4 to 326MHz	24	31		
	336.1 to 337MHz	36	41		

Table 3. LTR26RSH3 SAW Filter Characteristics

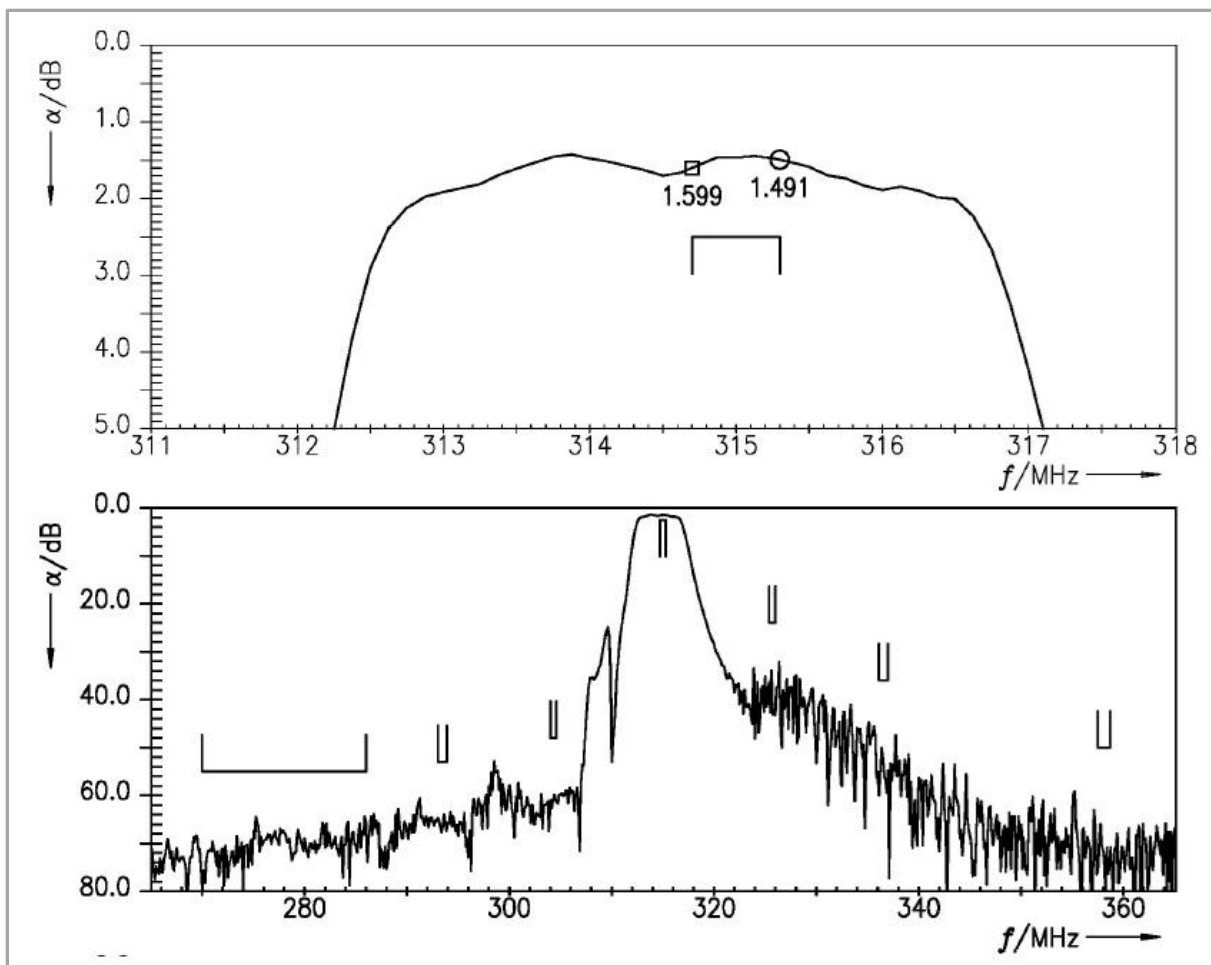

Fig.3 LTR26RSH3 RF Frontend SAW Filter Frequency Response

Due to highly selective SAW filter use, severe performance degradations might be expected when operating frequency selected does not fit inside filter BW, therefore for optimal receiver performance an operating frequency in 313MHz-316.5MHz range should be selected.

2. LTR26RSH3 Technical Data

The tables below give the electrical specifications for the LTR26RSH3 315MHz/+20dBm LoRa RF Transceiver Module operating with LoRa and FSK/(G)FSK modulation.

Symbol	Parameter	Test Conditions	Min	Typical	Max	Unit
F_{op}	Operational Frequency/Band	-	-	315	-	MHz
$S_{RFIN-FSK}$	Sensitivity-FSK	@4.8kbps, BW-20kHz	-	-117	-	dBm
		@0.6kbps, BW-4kHz	-	-122	-	
$S_{RFIN-LoRa}$	Sensitivity-LoRa	@SF10, BW-125kHz	-	-126	-	dBm
		@SF7, BW-500kHz	-	-116	-	
CCR_{FSK}	Co-channel Rejection-FSK			-9		dB
CCR_{LoRa}	Co-channel Rejection-LoRa	@SF12		19		dB
ACR_{FSK}	Adjacent-channel Rejection-FSK	+/-50kHz offset		45		dB
ACR_{LoRa}	Adjacent-channel Rejection-LoRa	+/-187kHz offset, SF-12		72		dB
BI_{FSK}	Blocking Immunity-FSK (4.8kbps, BW-20kHz)	+/-1MHz offset		68		dB
		+/-2MHz offset		70		
		+/-10MHz offset		80		
BI_{LoRa}	Blocking Immunity-LoRa (SF12, BW-125kHz)	+/-1MHz offset		88		dB
		+/-2MHz offset		90		
		+/-10MHz offset		99		
IMA	Image Attenuation-LoRa	with IQ calibration		54		dB
IIP_3	Third Order Intercept Point	Two tone test (1MHz/1.96MHz)	-	-5	-	dBm

Table 4. RF Radio Receiver /Receive Mode Characteristics

Symbol	Parameter	Test Conditions	Min	Typical	Max	Unit
F_{op}	Operational Frequency/Band	-	-	315	-	MHz
P_{RFOUT}	Maximum Output Power	-	-	+20	-	dBm
P_{RF-sat}	Power Change Step Size	Programmable	-	1	-	dB
P_{STEP}	RF Output Power Range	Programmable	-11	-	+20	dBm
P_{RMP}	RF Output Power Ramping Time	Programmable	10	-	3400	usec

Table 5. RF Radio Transmitter/Transmit Mode Characteristics

Symbol	Parameter	Test Conditions	Min	Typical	Max	Unit
F_{step}	Synthesizer Frequency Step Size	-	-	0.95	-	Hz
SF_{LoRa}	Spreading Factor-LoRa	Programmable	5	-	12	-
BR_{LoRa}	Bit Rate-LoRa	Programmable	0.018	-	62.5	kbps
BW_{LoRa}	Bandwidth-LoRa	Programmable	7.8	-	500	kHz
BR_{FSK}	Bit Rate-FSK	Programmable	0.6	-	300	kbps
FDA_{FSK}	Frequency Deviation-FSK	Programmable	0.6	-	200	kHz

Table 6. LoRa/FSK Modem and Frequency Synthesizer Characteristics

Symbol	Parameter	Test Conditions	Min	Typical	Max	Unit
V_{IH}	Input High Voltage		0.7*VCC	-	VCC+0.3	V
V_{IL}	Input Low Voltage		-0.3	-	0.3*VCC	V
V_{OH}	Output High Voltage		0.9*VCC	-	VCC	V
V_{OL}	Output Low Voltage		0	-	0.1*VCC	V
V_{IL_NRST}	Input High Voltage for NRST		-0.3	-	0.2*VCC	V

Table 7. Digital I/O Characteristics

Symbol	Parameter	Test Conditions	Min	Typical	Max	Unit
V_{cc}	Supply Voltage	-	1.8	3.3	3.6	V
I_{dd_SLP}	Current–Sleep mode		-	600	-	nA
I_{dd_TX}	Current–Transmit mode	@+20dBm RF Output	-	90	-	mA
I_{dd_RX}	Current–Receive mode		-	4.6	-	mA
T_{op}	Operational Temperature	-	-40	-	+85	°C

Table 8. Electrical Specifications

Absolute Maximum Ratings

“Absolute maximum ratings” may cause permanent damage to the device and is a stress rating only, functional operation of the device under these conditions for extended periods may affect device reliability.

Symbol	Parameter	Max	Unit
V_{DD}	Supply voltage	3.6	V
T_{op}	Operational Temperature	-40~+85	°C
T_{stg}	Storage Temperature	-50~+150	°C
ESD	ESD Rating	2(HBM)	kV

Table 9. Absolute Maximum Ratings

3. Interfacing LTR26RSH3 to Host Controller

The LTR26RSH3 is controlled via a serial SPI interface and a general-purpose input/output (DIO1) used for IRQ. The BIND (Busy Indicator) line is mandatory to ensure the host controller is ready to accept the commands. BIND is used as a busy signal indicating that the module is ready for new command only if this signal is low. When BIND is high, the host controller must wait until it goes down again before sending another command. Through SPI the application sends commands to the internal chip or accesses directly the data memory space.

Reset

A complete “factory reset” of the LLCC68 in module can be issued on request by toggling pin NRST of the LTR26RSH3. It will be automatically followed by the standard calibration procedure and any previous context will be lost. The pin should be held low for more typically 100µs for the Reset to happen.

SPI Interface

The SPI interface gives access to the configuration register via a synchronous full-duplex protocol corresponding to CPOL= 0 and CPHA = 0 and LTR26RSH3 behaves as slave. An address byte followed by a data byte is sent for a write access whereas an address byte is sent, and a read byte is received for the read access. The NSS pin goes low at the beginning of the frame and goes high after the data byte. MOSI is generated by the master on the falling edge of SCK and is sampled by the slave (i.e. this SPI interface) on the rising edge of SCK. MISO is generated by the slave on the falling edge of SCK. A transfer is always started by the NSS pin going low. MISO is high impedance when NSS is high. The SPI runs on the external SCK clock provided by the master.

SPI Timing When the Transceiver Leaves Sleep Mode

In Sleep mode and during the initialization phase, the busy signal mapped on BIND pin, is set high indicating to the host that the module is not able to accept a new command. Once the module is in STDBY_RC mode, the busy signal goes low, and the host can start sending a command. This is also true for startup at battery insertion or after a hard reset.

One way for the module to leave Sleep mode is to wait for a falling edge of NSS. At falling edge, all necessary internal regulators are switched On; the module starts initialization before being able to accept first SPI command. This means that the delay between the falling edge of NSS and the first rising edge of SCK must take into account the wake-up sequence and the initialization.

Through the SPI interface, the host can issue commands to the module or access the data memory space to directly retrieve or write data. In normal operation, a reduced number of direct data write operations is required except when accessing the data buffer. The user interacts with the circuit through an API (instruction set).

The LTR26RSH3 module BIND pin indicates the status of the module and its ability (or not) to receive another command while internal processing occurs. Prior to executing one of the generic functions, it is thus necessary to check the status of BIND to make sure the module is in a state where it can process another function.

Command Structure

In case of a command that does not require any parameter, the host sends only the opcode (1 byte). In case of a command which requires one or several parameters, the opcode byte is followed immediately by parameter bytes with the NSS rising edge terminating the command.

Transaction Termination

The host terminates an SPI transaction with the rising NSS signal; the host does not explicitly send the command length as a parameter. The host must not raise NSS within the bytes of a transaction. If a transaction sends a command requiring parameters, all the parameters must be sent before rising NSS, if not the module will take some unknown value for the missing parameters.

More details about SPI interface, command structures, registers and FIFO can be found in LLCC68 Datasheet.

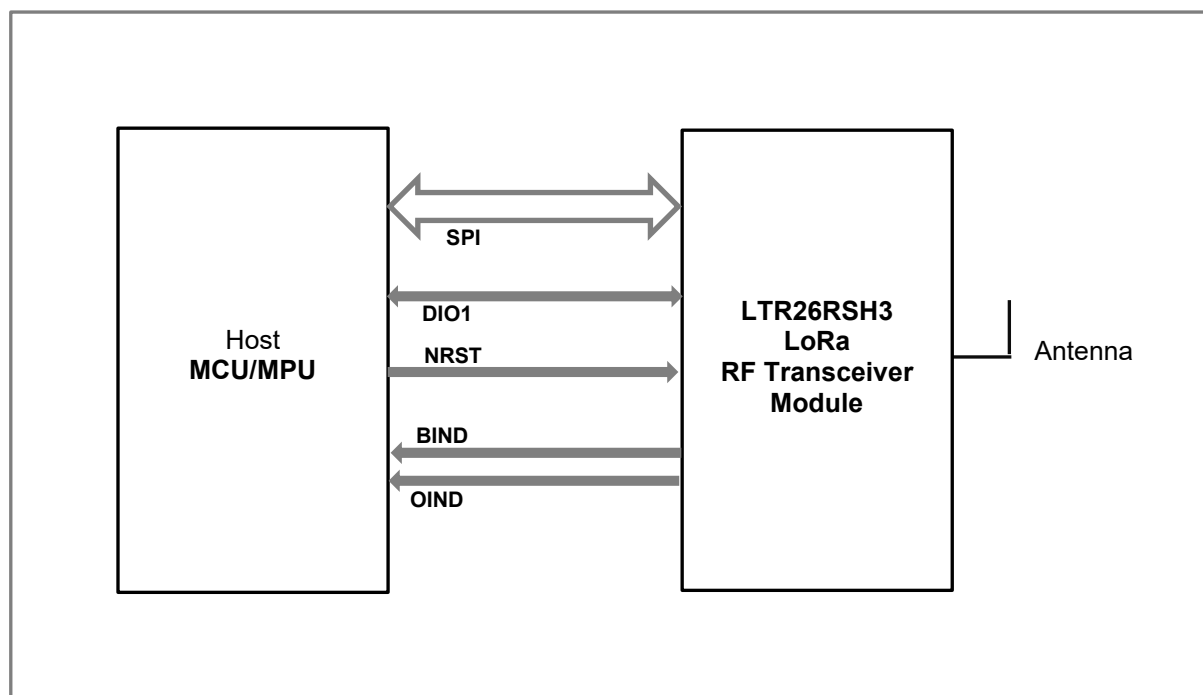

Fig.5 Interfacing LTR26RSH3 to MCU/MPU

4. Operational Modes

The LTR26RSH3 features six operating modes based on operating modes of LLCC68, each operating mode is explained in the following table and details of operational modes can be found in LLCC68 Datasheet.

Operation Mode	Enabled Blocks
SLEEP	Optional registers, backup regulator, RC64k oscillator, data RAM
STANDBY_RC	Top regulator (LDO), RC13M oscillator
STANDBY_XOSC	Top regulator (DC-DC or LDO), XOSC
FS	All of the above + Frequency synthesizer at Tx frequency
TX	Frequency synthesizer and transmitter, Modem
RX	Frequency synthesizer and receiver, Modem

Table 10. LTR26RSH3 Operational Modes

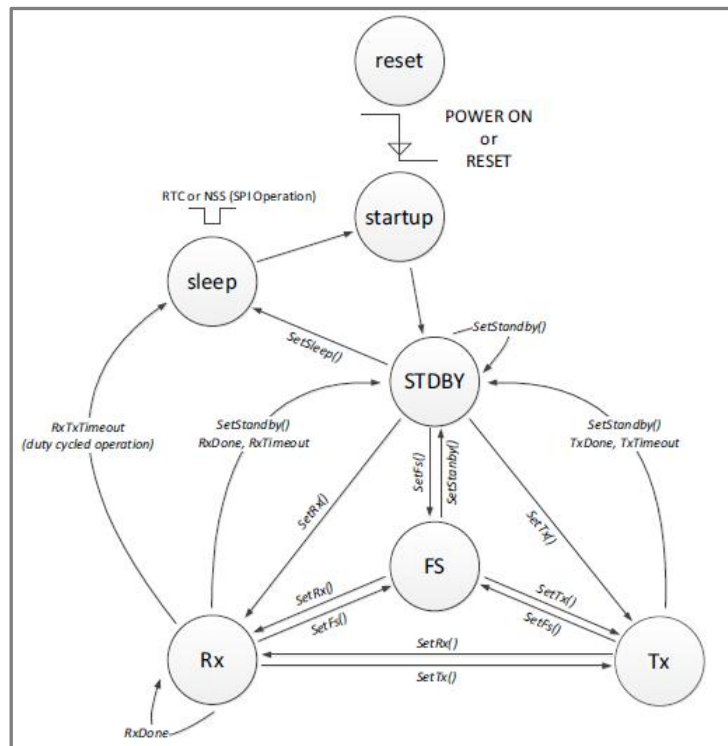

Fig.6 LTR26RSH3 Operational Modes

5. Setting Modem, Transmitter & Receiver Parameters

The LLCC68 and consequently LTR26RSH3 contain different modems capable of handling LoRa and FSK modulations. LoRa and FSK are associated with their own frame and modem.

The user specifies the modem and frame type by using the command *SetPacketType(...)*. This command specifies the frame used and consequently the modem implemented. This function is the first one to be called before going to Rx or Tx and before defining frequency, modulation and packet parameters.

LoRa Modulation Technique and LoRa Parameters

The LoRa modem uses spread spectrum modulation and forward error correction techniques to increase the range and robustness of radio communication links compared to traditional FSK based modulation. An important facet of the LoRa modem is its increased immunity to interference. The LoRa modem is capable of co-channel GMSK rejection of up to 19dB. This immunity to interference permits the simple coexistence of LoRa modulated systems either in bands of heavy spectral usage or in hybrid communication networks that use LoRa to extend range when legacy modulation schemes fail.

Modulation Parameters

It is possible to optimize the LoRa modulation for a given application, access is given to the designer to four critical design parameters, each one permitting a trade-off between the link budget, immunity to interference, spectral occupancy and nominal data rate. These parameters are:

- Modulation BandWidth (BW_L)
- Spreading Factor (SF)
- Coding Rate (CR)
- Low Data Rate Optimization (LDRO)

These parameters are set using the command *SetModulationParams(...)* which must be called after *SetPacketType(...)*.

LoRa has its own packet engine that supports the LoRa PHY. More details about LoRa Modem, LoRa Modulation Parameters, LoRa Packet Engine, LoRa Frame and LoRa Channel Activity Detection (CAD) can be found in LLCC68 Datasheet.

FSK/(G)FSK Modulation Technique and FSK/(G)FSK Parameters

The FSK modem can perform transmission and reception of 2-FSK modulated packets over a range of data rates from 0.6 kbps to 300 kbps. All parameters are set by using the command *SetModulationParams(...)*. This function should be called only after defining the protocol. The bitrate setting is referenced to the crystal oscillator and provides a precise means of setting the bit rate (or equivalently chip) rate of the radio.

The LLCC68 and consequently LTR26RSH3 is designed for packet-based transmission. The packet controller block is responsible for assembly of the received data bit-stream into packets and their storage into the data buffer. It also performs the bit-stream decoding operations such as de-whitening & CRC-checks on the received bit-stream. On the transmit side, the packet handler can construct a packet and send it bit by bit to the modulator for transmission. It can whiten the payload and append the CRC-checksum to the end of the packet. The packet controller only works in half-duplex mode i.e. either in transmit or receive at a time. The packet controller is configured using the command *SetPacketParams(...)*

More details about FSK Modem, FSK Modulation Parameters, FSK Packet Format, FSK Frame and CRC use in FSK can be found in LLCC68 Datasheet.

RF Frequency, PA and TX Parameters

RF Frequency Setting

The command *SetRfFrequency(...)* is used to set the frequency of the RF frequency mode. The LSB of Freq is equal to the PLL step giving:

$$Rf\text{frequency} = \frac{RfFreqxFXTAL}{2^{25}}$$

SetRfFrequency(...) defines the chip frequency in FS, TX and RX modes. In RX, the frequency is internally lowered to IF (250kHz by default).

Byte	0	1-4
Data from Host	Opcode=0x86	RFfreq(31:0)

Table 11. RF Frequency Setting

RF Frequency	RFfreq(31:0)
315MHz	0x13B00000
312MHz	0x13800000
314MHz	0x13A00000
316MHz	0x13C00000
318MHz	0x13E00000

Table 11B. LTR26RSH3 Typical Frequency Settings

PA Configuration

LTR26RSH3 PA matching hardware is optimal for +20dBm RF output power, therefore a sample set of PA settings are provided here.

paDutyCycle controls the duty cycle (conduction angle). The maximum output power, the power consumption, and the harmonics will drastically change with *paDutyCycle*. Changing the *paDutyCycle* will affect the distribution of the power in the harmonics and should be selected to work in conjunction with a given matching network. For implemented matching network, *paDutyCycle* can be selected as 0x04.

hpMax selects the size of the PA. The maximum output power can be reduced by reducing the value of *hpMax*. For implemented matching network, *hpMax* can be selected as 0x07.

deviceSel is reserved and has always the value 0x00.

paLut is reserved and has always the value 0x01.

PA Optimal Settings

Byte	0	1	2	3	4
Data from Host	Opcode=0x98	paDutyCycle	hpMax	deviceSel	paLut

Table 12. PA Settings

Byte	0	1	2	3	4
Data from Host	Opcode=0x98	0x04	0x07	0x00	0x01

Table 12B. LTR26RSH3 Recommended PA Settings

TX Parameters

SetTxParams command sets the TX output power by using the parameter *power* and the TX ramping time by using the parameter *RampTime*.

The power ramp time is defined by the parameter *RampTime* as defined in the following table

Byte	0	1	2
Data from Host	Opcode=0x8E	power	RampTime

Table 13. TX Settings

Byte	0	1	2
Data from Host	Opcode=0x8E	0x16	0x00

Table 13B. LTR26RSH3 Recommended TX Settings

RampTime	Value	RampTime(us)
SET_RAMP_10U	0x00	10
SET_RAMP_20U	0x01	20
SET_RAMP_40U	0x02	40
SET_RAMP_80U	0x03	80
SET_RAMP_200U	0x04	200
SET_RAMP_800U	0x05	800
SET_RAMP_1700U	0x06	1700
SET_RAMP_3400U	0x07	3400

Table 14. PA Ramp Time Settings

6. Module Aspects To Consider for User Application

LTR26RSH3 LoRa RF Transceiver module uses low ppm XTAL for high frequency stability and also an RF switch for TX and RX path switching in transmit and receive modes respectively. The user application code should contain proper settings for DC-DC or LDO Only mode of regulator operation, XTAL use, RF switch use and proper calibration as detailed in following sections.

LDO Only or DC-DC Mode of Operation

In LLCC68 two forms of voltage regulation (DC-DC buck converter or linear LDO regulator) are available, the linear LDO regulator is always present in all modes but the transceiver will use DC-DC when selected. By default, only the LDO is used. *SetRegulatorMode(...)* function specifies if DC-DC or LDO is used for power regulation. The user can specify the use of DC-DC by using the command *SetRegulatorMode(...)*. This operation must be carried out in STDBY_RC mode only. The regulation mode is defined by parameter *regModeParam*.

Byte	0	1
Data from Host	Opcode=0x96	regModeParam 0: Only LDO used for all modes 1: DC DC+LDO for STBY_XOSC,FS, RX and TX

Table 15. Regulator Mode Selection

Hardware implementation of the LTR26RSH3 allows using LDO only or LDO plus DC-DC mode of operations.

Image Calibration for 315MHz Frequency Band

Image calibration is done through the command *CalibrateImage(...)* for a given range of frequencies defined by the parameters *freq1* and *freq2*. Once performed, the calibration is valid for all frequencies between the two extremes used as parameters. Typically, the user can select the parameters *freq1* and *freq2* to cover any specific ISM band.

Byte	0	1	2
Data from Host	Opcode=0x98	freq1	freq2

Table 18. Image Calibration for 315MHz frequency band

By default, the image calibration is made in the band 902-928MHz, therefore it should be repeated by requesting the device to perform a new image calibration for 315MHz frequency band by defining 310-320MHz band.

Frequency Band	freq1	freq2
310MHz-320MHz	0x4D	0x51

Table 19. Image Calibration Frequencies

Use of RF Switch (controlled by DIO2)

LTR26RSH3 uses an RF switch to activate/deactivate TX and RX paths in transmit and receive modes respectively, and RF switch used is controlled by DIO2 multifunction I/O pin of LLCC68, therefore the user application should take use of DIO2 into account detailed as follows.

DIO2 should be configured to drive the RF switch through the use of the command *SetDio2AsRfSwitchCtrl(...)*. In this mode, DIO2 will be at a logical 1 during Tx and at a logical 0 in any

other mode. DIO2 will be asserted high a few microseconds before the ramp-up of the PA and will be set to zero after the ramp-down of the PA.

Byte	0	1
Data from Host	Opcode=0x9D	enable

Table 20. DIO2 RF Switch Configuration

The enable byte definition is given as follows:

Enable	Description
0x00	DIO2 is free to be used as an IRQ
0x01	DIO2 is selected to be used to control an RF switch. In this case: DIO2 = 0 in SLEEP, STDBY_RX, STDBY_XOSC, FS and RX modes, DIO2 = 1 in TX mode

Table 21. DIO2 Options

Note:

For proper operation of the LTR26RSH3, the DIO2 should be configured accordingly by enabling with 0x01 parameter.

Application Code Structure and Issuing Commands in the Right Order

LTR26RSH3 hardware is suitable for LDO only or DC-DC regulator mode of operation and includes an RF switch controlled by DIO2 of LLCC68, therefore related IRQ/DIO mask settings, RF switch settings should be configured, transmit and receive buffer base addresses should be defined and a calibration should be performed before radio configuration and operation.

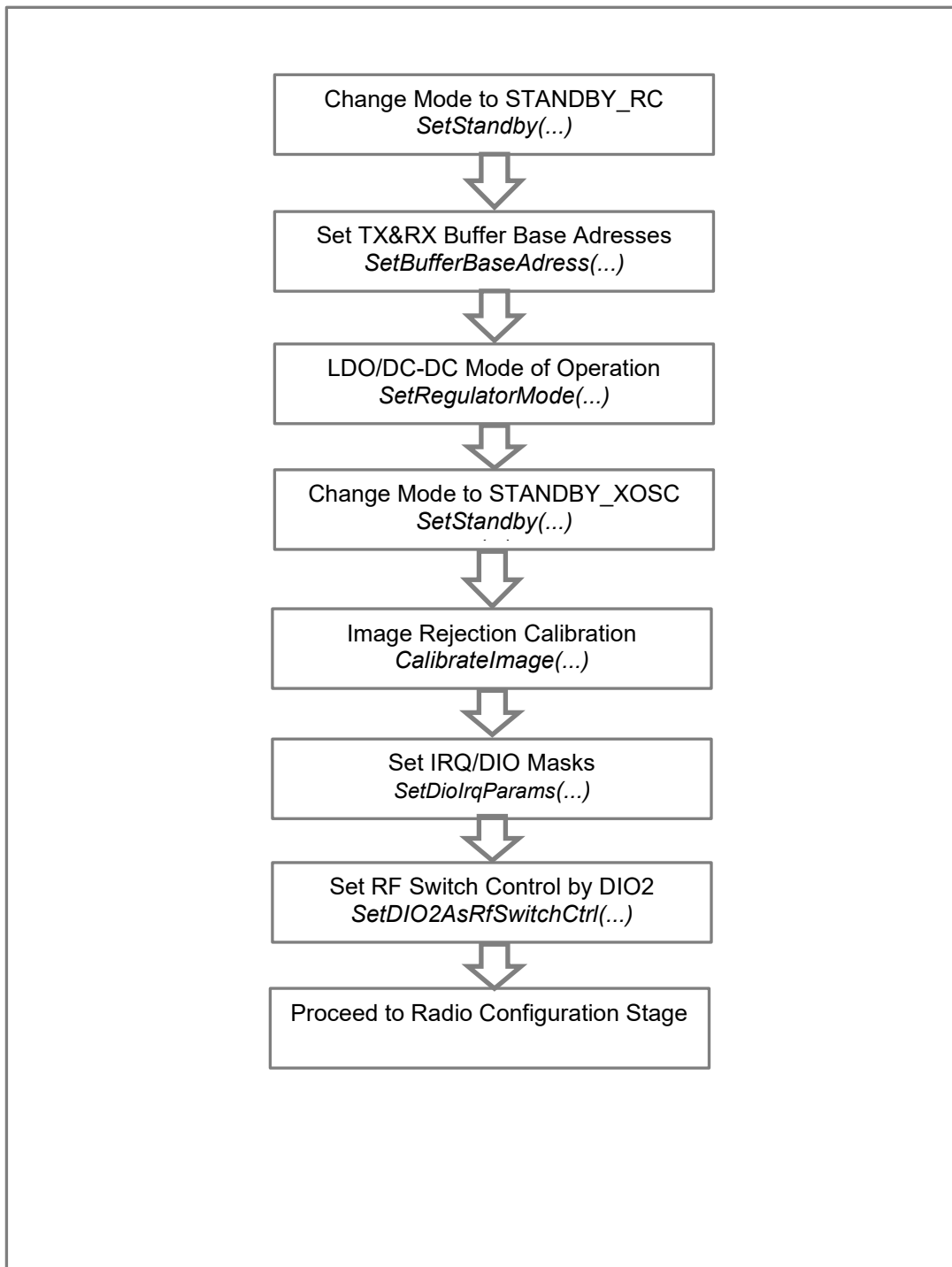

Fig.7 Configuration and Settings - Standby Mode

Most of the commands can be sent in any order except for the radio configuration commands which will set the radio in the proper operating mode.

It is mandatory to set the radio protocol using the command *SetPacketType(...)* as a first step before issuing any other radio configuration commands.

In a second step, the user should define the modulation parameter according to the chosen protocol with the command *SetModulationParams(...)*.

Finally, the user should then select the packet format with the command *SetPacketParams(...)*.

Note: If this order is not respected, the behavior of the device could be unexpected

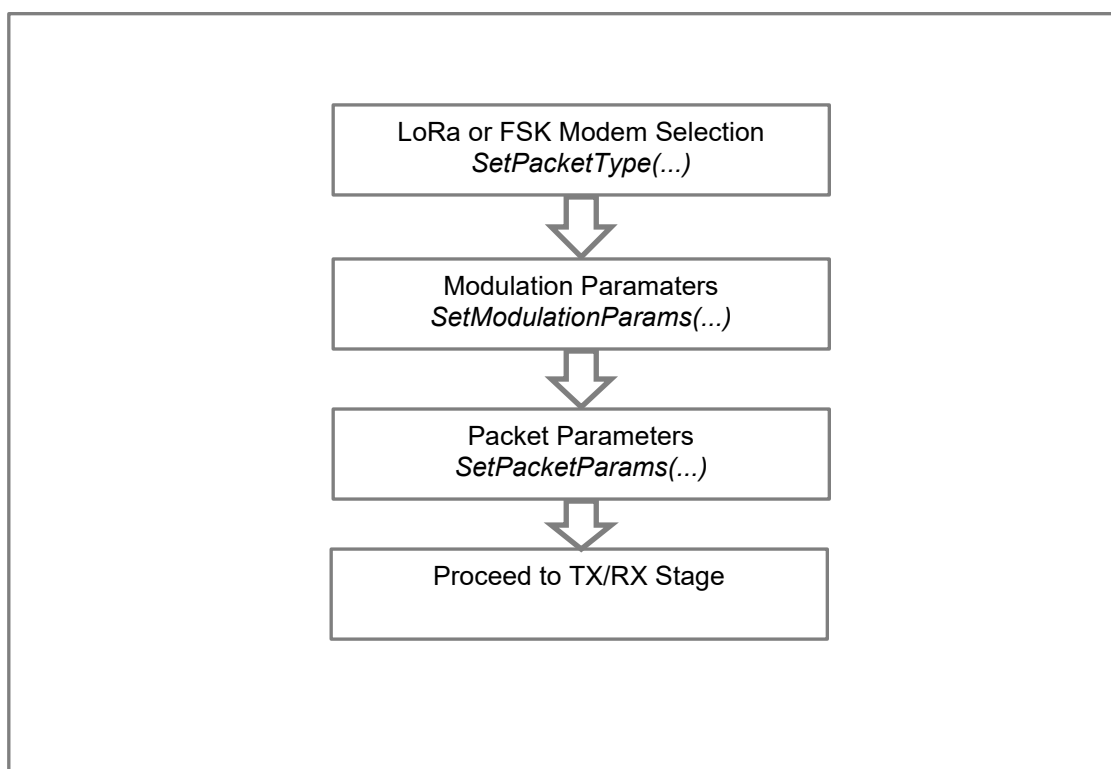

Fig.8 Configuration and Settings - Modem Selection, Modulation and Packet Parameters

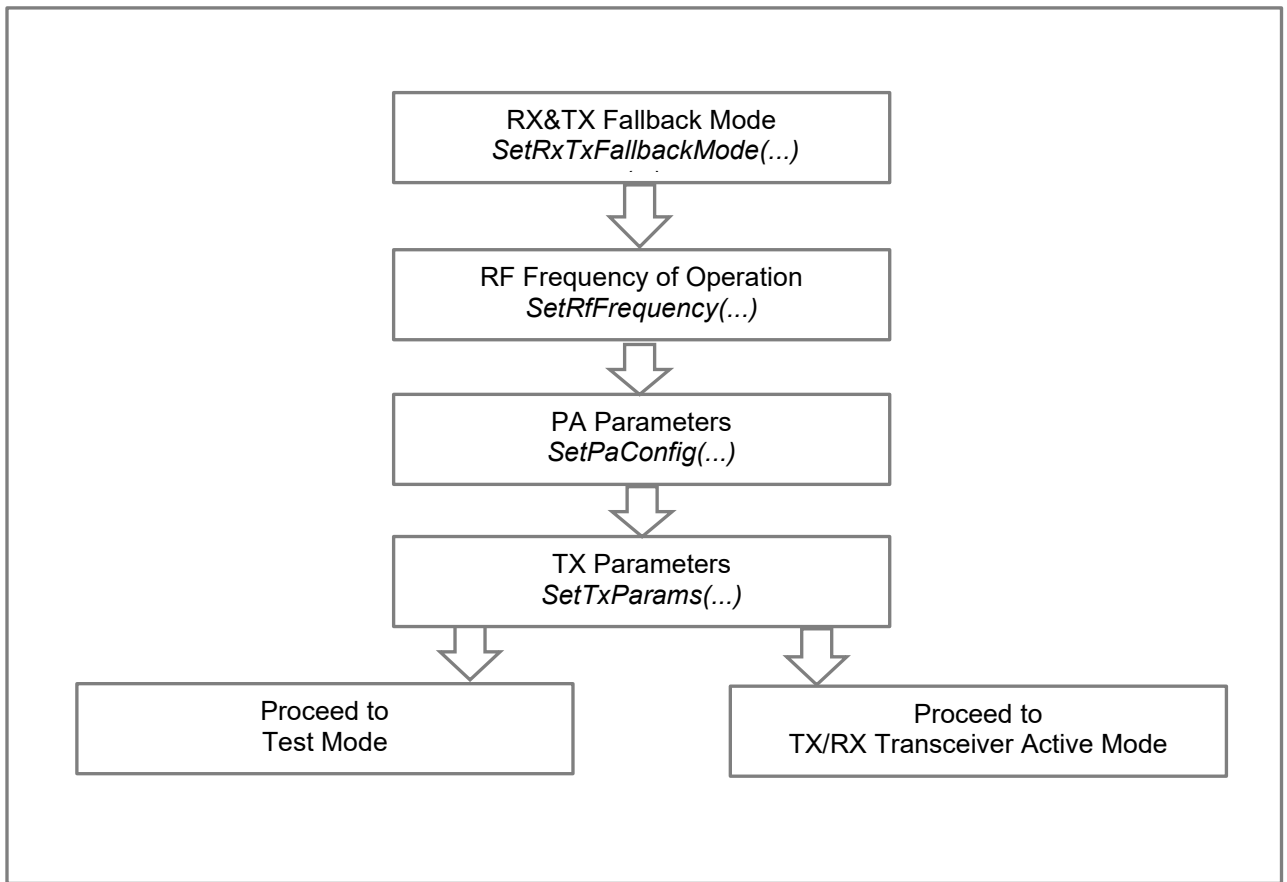

Fig.9 Configuration and Settings – RF Frequency, PA and TX/RX Parameters

7. Drawings

Figure.10 depicts a description of connector pinout and module dimensions for LTR26RSH3, a detailed description of the individual pins can be found in Table 22 Connector and Pin Descriptions.

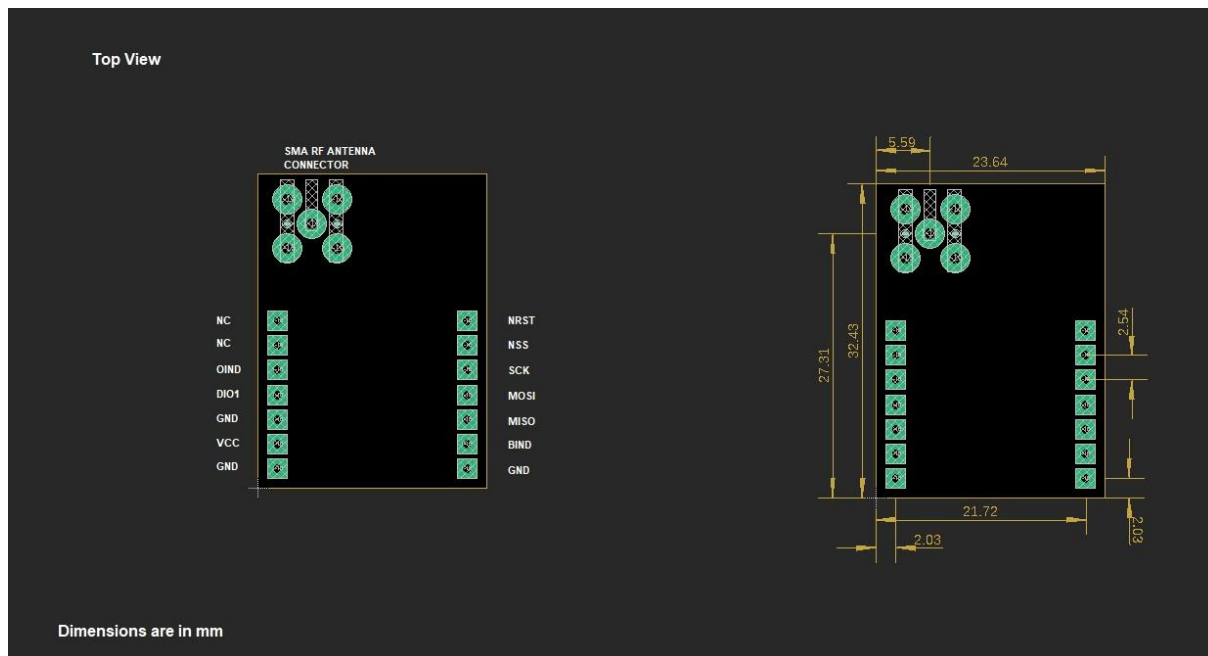

Fig.11 LTR26RSH3 Pin and Size Diagram

CONNECTORS		
Pin No	Pin Name	Pin Function
CA	ANT	RF Output/Antenna
J1-Connector		
J1-1	N/C	No Connection (Internally GND)
J1-2	N/C	No Connection (Internally GND)
J1-3	OIND	Operation Indicator
J1-4	DIO1	Data I/O
J1-5	GND	0V, Ground
J1-6	VCC	+Supply Voltage
J1-7	GND	0V, Ground
J2-Connector		
J2-1	NRST	Reset
J2-2	NSS	SPI chip select
J2-3	SCK	SPI clock
J2-4	MOSI	SPI MOSI
J2-5	MISO	SPI MISO
J2-6	BIND	Busy Indicator
J2-7	GND	0V, Ground

Table 22. Connector and Pin Descriptions (LTR26RSH3)

8. Ordering Information

Order Code	Description	
LTR26RSH3	LTR26RSH3 315MHz/+20dBm LoRa RF Transceiver Module (with RF Shield and SMA RF Connector)	

Table 23. LTR26RSH3 Ordering Info

Revision History

Date	Revision	Modifications
July 12, 2025	1.1	Initial release

References

- 1) Semtech LLCC68 Datasheet - <https://www.egn-elektronik.com.tr/EN/Datasheets/LLCC68.pdf>
- 2) LLCC68 Drivers - https://github.com/Lora-net/llcc68_driver